

**Novità**  
New



VZ 120-80

Pratico sistema di vassoi metallici realizzati in lamiera d'acciaio zincata, ideali per contenere e movimentare piccoli contenitori ed anche sostanze infiammabili. Le dimensioni dei vari modelli consentono una perfetta ottimizzazione in caso di movimentazione con Europallet.

Da soli o in composizione, rappresentano un economico sistema di stoccaggio.

A richiesta è possibile inserire in ogni modello il pratico grigliato zincato.

*Practical galvanized sump trays, suitable for the storage and handling of small containers or flammable substances. The dimensions of these sump trays allow a perfect optimization of an Europallet.*

*Available as a single unit or in a composition, these trays are an easy and economical storage system.*

*Available for each version a practical galvanized grid.*



VZ 80-60

VASCA PER PICCOLI CONTENITORI, VOLUME DA 40 LITRI  
SUMP TRAY FOR SMALL CONTAINERS - 40 LITRE VOLUME



VZ 80-60  
VZ 60-40

1 VASCA DA 40 LITRI ED 1 VASCA DA 20 LITRI COMBinate SU UN EUROPALETTE, CON LO SPAZIO LIBERO PER UN' ULTERIORE VASCA  
COMPOSITION FOR EUROPALETTE - TRAYS FOR SMALL CONTAINERS 40-LITRE AND 20-LITRE. FREE SPACE FOR AN ADDITIONAL TRAY



VZ 60-40

VASCA PER PICCOLI CONTENITORI, VOLUME DA 20 LITRI  
SUMP TRAY FOR SMALL CONTAINERS - 20 LITRE VOLUME

POSSIBILI  
COMBINAZIONI  
DI VASCHE  
PER PICCOLI  
CONTENITORI SU  
UN EUROPALETTE

POSSIBLE  
COMPOSITIONS  
OF TRAYS FOR  
SMALL CONTAINERS  
ON EURO PALLET



VZ 60-40  
4 vasche per piccoli  
contenitori  
4x20 litri  
4 sumps for small  
containers  
4x20 litre



VZ 80-60  
3 vasche per piccoli  
contenitori  
2x20 litri - 1x40 litri  
3 sumps for small  
containers  
2x20 litre - 1x40 litre

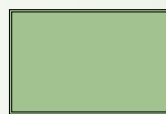

VZ 120-80  
1 vasca per piccoli  
contenitori  
1x60 litri  
1 sump for small  
container  
1x60 litre



GR 60-40

GRIGLIATO  
GRID

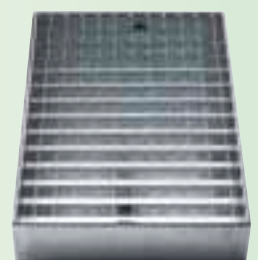

SU RICHIESTA DISPONIBILI CON GRIGLIATO ZINCATO  
ON REQUEST AVAILABLE WITH GALVANIZED GRID

MODELLO MODEL	VZ 60-40	VZ 80-60	VZ 120-80
Volume di raccolta (l) collection volume	20	40	60
Misure esterne: Larg. x Prof. x Alt. (mm) External Dimensions: Width x Depth x Height (mm)	600x400x100	800x600x100	1190x790x100
Portata kg Capacity kg	50	100	200
Accessorio grigliato: codice articolo zincato Accessory: galvanized grid - article code	GR 60-40	GR 80-60	GR 120-80

# VASCHE DI RACCOLTA CONICHE IN ACCIAIO ZINCATO

## CONICAL SUMP PALLETS IN GALVANIZED SHEET STEEL

# A



- Vasche di raccolta CONICHE per lo stoccaggio a norma di fusti da 200 Lt e piccoli contenitori.
- Realizzate in lamiera d'acciaio zincata.
- Grigliato zincato asportabile.
- Conforme alle normative Europee di sicurezza.
- Prodotto ideale per la rivendita.

- *CONICAL sumps tray for safety storage of 200 lt drums and small containers - in compliance with regulations.*
- *Made of hot-dip galvanized steel sheet.*
- *Removable hot-dip galvanized grid.*
- *In conformity with the European safety Standards.*
- *Suitable for resellers*

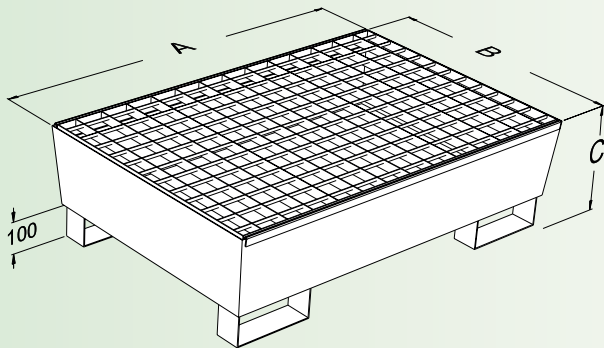

**Novità**  
New



MODELLO MODEL	DIMENSIONI DIMENSIONS			CAPACITÀ DI STOCCAGGIO STORAGE CAPACITY
	A	B	C	
EKON 101Z	800	800	450	1 fusto da 200 Lt. 1 x 200 l. drum



MODELLO MODEL	DIMENSIONI DIMENSIONS			CAPACITÀ DI STOCCAGGIO STORAGE CAPACITY
	A	B	C	
EKON 102Z	1200	800	340	2 fusti da 200 Lt. 2 x 200 l. drums

GRAZIE ALLA PARTICOLARE FORMA CONICA POSSONO ESSERE INSERITE UNA NELL'ALTRA CON UNA SENSIBILE RIDUZIONE DELL'INGOMBRO IN FASE DI TRASPORTO.

THANKS TO THE CONICAL CONSTRUCTION CAN BE STACKED INSIDE EACH OTHER - WITH A GREAT REDUCTION OF THE SPACE DURING THE TRANSPORT.



MODELLO MODEL	DIMENSIONI DIMENSIONS			CAPACITÀ DI STOCCAGGIO STORAGE CAPACITY
	A	B	C	
EKON 104Z	1200	1200	300	4 fusti da 200 Lt. 4 x 200 l. drums

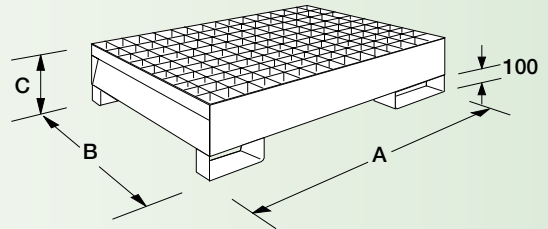

MODELLO MODEL	DIMENSIONI DIMENSIONS			CAPACITÀ DI STOCCAGGIO STORAGE CAPACITY
	A	B	C	
ECO 301	860	860	430	1 fusto da lt. 200 direttamente su grigliato <i>1x200 l drum directly on grille</i>



**CONFORMI ALLE NORMATIVE EUROPEE DI SICUREZZA  
IN CONFORMITY WITH EUROPEAN SAFETY STANDARDS**



TARGHETTA IDENTIFICATIVA E D'IMMATRICOLAZIONE  
IDENTIFICATION PLATE

MODELLO MODEL	DIMENSIONI DIMENSIONS			CAPACITÀ DI STOCCAGGIO STORAGE CAPACITY
	A	B	C	
ECO 302	1340	850	330	2 fusti da lt. 200 direttamente su grigliato o su europallet 1200x800 <i>2x200 l drums directly on grille or on europallet 1200x800</i>



MODELLO MODEL	DIMENSIONI DIMENSIONS			CAPACITÀ DI STOCCAGGIO STORAGE CAPACITY
	A	B	C	
ECO 304	1340	1250	300	4 fusti da lt. 200 direttamente su grigliato o su pallet 1200x1200 <i>4x200 l drums directly on grille or on pallet 1200x1200</i>

# VASCHE DI RACCOLTA IN ACCIAIO

## STEEL SUMP PALLETS

# A

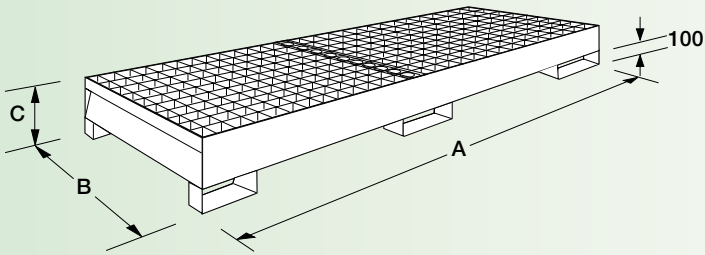

MODELLO MODEL	DIMENSIONI DIMENSIONS			CAPACITÀ DI STOCCAGGIO STORAGE CAPACITY
	A	B	C	
ECO 303	2010	850	330	3 fusti da lt. 200 direttamente su grigliato 3x200 l drums directly on grille



MODELLO MODEL	DIMENSIONI DIMENSIONS			CAPACITÀ DI STOCCAGGIO STORAGE CAPACITY
	A	B	C	
ECO 304 F	2660	850	330	4 fusti da lt. 200 direttamente su grigliato o 4 su 2 europallet 4x200 l drums directly on grille or 4 on 2 europallet



VASCHE DOTATE DI PANNELLI MONITORI  
WARNING PANELS FITTED TO THE SUMP



MODELLO MODEL	DIMENSIONI DIMENSIONS			CAPACITÀ DI STOCCAGGIO STORAGE CAPACITY
	A	B	C	
ECO 308 F	2720	1250	300	8 fusti da lt. 200 direttamente su grigliato o 6 fusti da lt. 200 su 3 europallet o 8 fusti da lt. 200 su 2 pallet 1200x1200 8x200 l drums directly on grille or 6x200 l drums on 3 europallets or 8x200 l drums on 2 pallets 1200x1200

# A

## VASCA CON PARETI LATERALI FISSE PARASPRUZZI SUMP PALLETS WITH FIXED SPLASH GUARD SIDES

VASCA CON PARETI LATERALI FISSE PARASPRUZZI  
SUMP PALLET WITH FIXED SPLASH GUARD SIDES



ECO 804

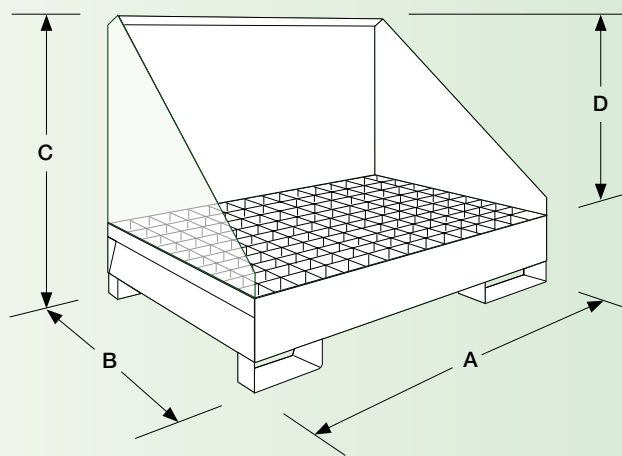

MODELLO MODEL	DIMENSIONI DIMENSIONS				CAPACITÀ DI STOCCAGGIO STORAGE CAPACITY
	A	B	C	D	
ECO 801	860	860	1400	970	1 fusto da 200 lt. direttamente su grigliato <i>1x200 l drum directly on grille</i>
ECO 802	1340	850	1400	1070	2 fusti da 200 lt. direttamente su grigliato o su europallet 1200x800 <i>2x200 l drums directly on grille or on europallet 1200x800</i>
ECO 804	1340	1250	1370	1070	4 fusti da 200 lt. direttamente su grigliato o su pallet 1200x1200 <i>4x200 l drums directly on grille or on pallet 1200x1200</i>

**CONFORMI ALLE NORMATIVE EUROPEE DI SICUREZZA  
IN CONFORMITY WITH EUROPEAN SAFETY STANDARDS**

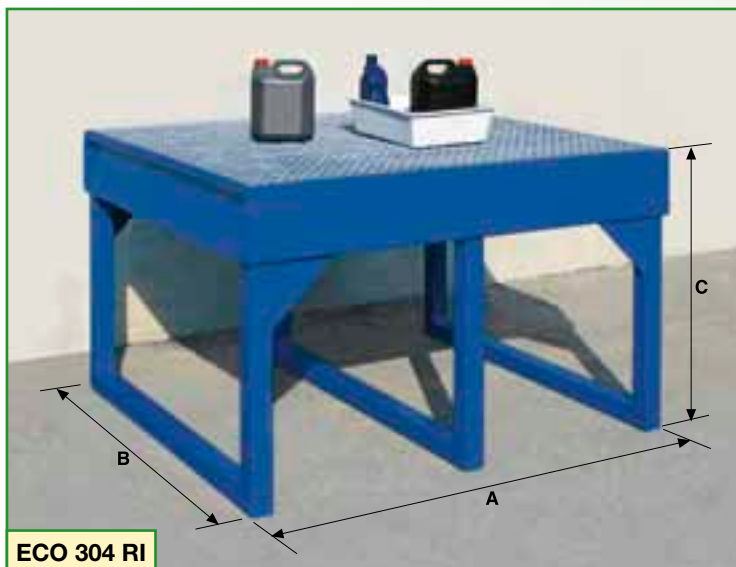

ECO 304 RI

Vasca di raccolta rialzata, utilizzabile come banco per il travaso di contenitori e per la manutenzione di oggetti a contatto con materiali inquinanti.

*Raised collection tank, usable as a bench for transfer of containers and servicing objects in contact with polluting materials.*

MODELLO MODEL	DIMENSIONI DIMENSIONS		
	A	B	C
ECO 302 RI	1340	850	850
ECO 304 RI	1340	1250	850

# PARETI PARASPRUZZI ASPORTABILI IN LAMIERA ZINCATA

## REMOVABLE GALVANISED SPLASH GUARD SIDES

# A



**SISTEMI DI STOCCAGGIO SICURI**  
**SAFETY STORAGE SYSTEMS**

Pareti laterali paraspruzzi asportabili in lamiera zincata da applicare alle vasche a tenuta stagna. Realizzate con lamiera zincata di spessore 1,5 mm.

*Removable galvanised splash guard sides, to be fitted to the watertight tanks. Made from 1.5 mm thick galvanised sheet metal.*

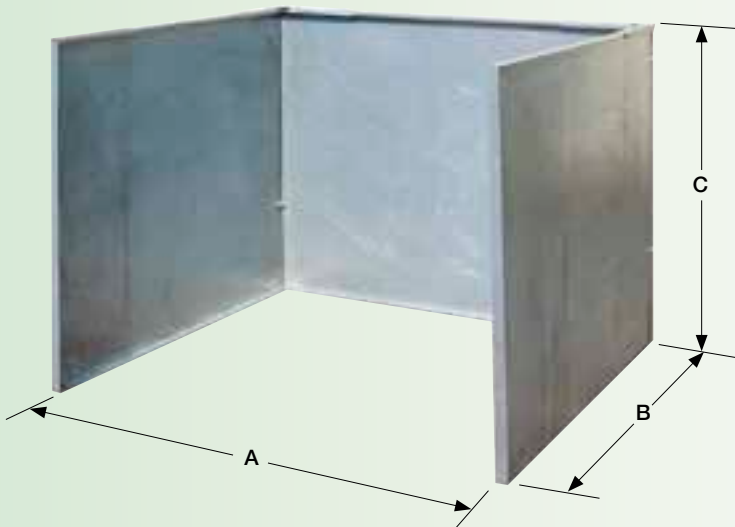

MODELLO MODEL	DIMENSIONI DIMENSIONS			UTILIZZO USE
	A	B	C	
SPS 015Z	850	850	1000	Applicabile alla vasca Can be fitted to tank Eco 301
SPS 016Z	1330	840	1000	Applicabile alla vasca Can be fitted to tank Eco 302
SPS 017Z	1330	1240	1000	Applicabile alla vasca Can be fitted to tank Eco 304



ECO 404



### 3 LATI CON FASCE

#### 3 SIDES WITH BANDS

MODELLO MODEL	DIMENSIONI DIMENSIONS				CAPACITÀ DI STOCCAGGIO STORAGE CAPACITY
	A	B	C	D	
ECO 401	870	870	1460	970	1 fusto da 200 lt. direttamente su grigliato 1x200 l drum directly on grille
ECO 402	1350	860	1460	1070	2 fusti da 200 lt. direttamente su grigliato o su europallet 1200x800 2x200 l drums directly on grille or on europallet 1200x800
ECO 404	1350	1260	1430	1070	4 fusti da 200 lt. direttamente su grigliato o su pallet 1200x1200 4x200 l drums directly on grille or on pallet 1200x1200



ECO 504

### 3 LATI TAMPONATI IN RETE

#### 3 SIDES CLOSED WITH MESH

MODELLO MODEL	DIMENSIONI DIMENSIONS				CAPACITÀ DI STOCCAGGIO STORAGE CAPACITY
	A	B	C	D	
ECO 501	870	870	1460	970	1 fusto da 200 lt. direttamente su grigliato 1x200 l drum directly on grille
ECO 502	1350	860	1460	1070	2 fusti da 200 lt. direttamente su grigliato o su europallet 1200x800 2x200 l drums directly on grille or on europallet 1200x800
ECO 504	1350	1260	1430	1070	4 fusti da 200 lt. direttamente su grigliato o su pallet 1200x1200 4x200 l drums directly on grille or on pallet 1200x1200



ECO 604

### 3 LATI TAMPONATI IN LAMIERA

#### 3 SIDES CLOSED WITH SHEET METAL

MODELLO MODEL	DIMENSIONI DIMENSIONS				CAPACITÀ DI STOCCAGGIO STORAGE CAPACITY
	A	B	C	D	
ECO 601	870	870	1460	970	1 fusto da 200 lt. direttamente su grigliato 1x200 l drum directly on grille
ECO 602	1350	860	1460	1070	2 fusti da 200 lt. direttamente su grigliato o su europallet 1200x800 2x200 l drums directly on grille or on europallet 1200x800
ECO 604	1350	1260	1430	1070	4 fusti da 200 lt. direttamente su grigliato o su pallet 1200x1200 4x200 l drums directly on grille or on pallet 1200x1200

**TRASPORTO E STOCCAGGIO IN SICUREZZA  
CON LE PROTEZIONI LATERALI**  
**SAFE TRANSPORT AND STORAGE  
THANKS TO SIDE GUARDS**

**STAZIONI SOVRAPPONIBILI PER LO STOCCAGGIO DI  
SOSTANZE PERICOLOSE, INQUINANTI.**  
Questi sistemi sovrapponibili permettono lo stoccaggio di grandi  
quantità di materiali pericolosi con notevole risparmio di spazio.  
Le pareti su tre lati garantiscono inoltre la massima sicurezza  
durante il trasporto all'interno dello stabilimento.  
Sovrapponibile fino a tre livelli.

**STACKABLE STATIONS FOR STORING HAZARDOUS AND POLLUTING  
SUBSTANCES.**  
*These stackable systems permit storing large quantities of hazardous  
materials with considerable space saving.  
Guards on three sides provide utmost safety during transport inside the  
factory. Triple-level stacking option.*

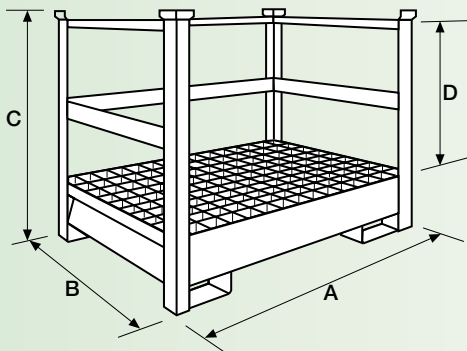

**Possibilità di combinare lo stoccaggio verticale ed  
orizzontale e/o di piccoli contenitori utilizzando  
allestimenti interni componibili**

*Possibility of combining vertical and horizontal storage  
and/or small containers using modular internal  
components*

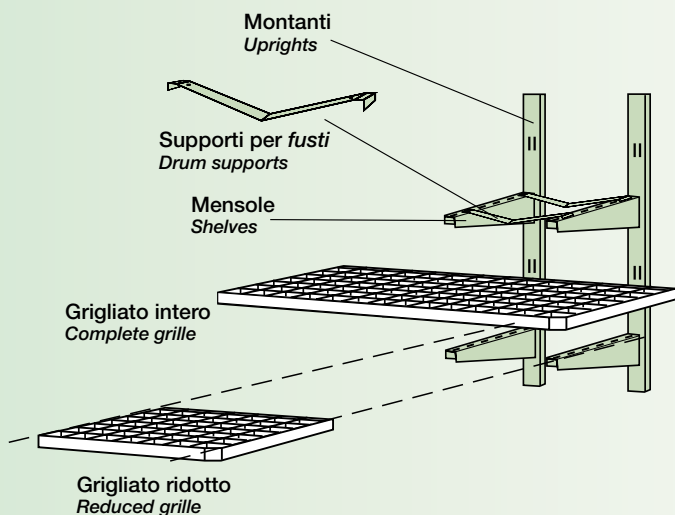

**ECO 404**



**ECO 602**

**ACCESSORIATO CON: EQUIPPED WITH:**

- 1 coppia montanti • 1 pair of uprights
- 1 coppia mensole • 1 pair of shelves
- 1 grigliato intero • 1 complete grille





ECO 309 CR

### VASCHE MOBILI DI RACCOLTA VERNICIATE

- Concepite appositamente per le movimentazioni all'interno dell'azienda.
- Facile movimentazione grazie al maniglione di spinta e a 2 ruote fisse e a 2 piroettanti con freno.
- Consentono lo stoccaggio in verticale dei fusti e, con l'impiego dei supporti opzionali, anche in posizione orizzontale
- Su richiesta è disponibile la cinghia di trattenuta fusti con staffa di fissaggio per una maggiore sicurezza in fase di trasporto.

### PAINTED FINISHING MOBILE STEEL SUMPS

- Designed for an easy and safe handling within the Company area.
- Easy to move thanks to the handle and the 2 fixed and the 2 swivel castors with brake.
- Vertical drums storage and, with the additional support, also horizontally.
- On request also available a drum securing strap for a safe transport.

MODELLO MODEL	DIMENSIONI DIMENSIONS			CAPACITÀ DI STOCCAGGIO STORAGE CAPACITY
	A	B	C	
ECO 309 CR	860	860	1170	1 fusto da 200 lt. direttamente su grigliato 1x200 l drum directly on grille



DISPONIBILE ANCHE ZINCATO  
ALSO AVAILABLE IN HOT  
GALVANIZED FINISHING

RUOTE CON FRENO  
WHEELS WITH BRAKE



SPF 451

ECO 310 CR



ECO 310 CR

MODELLO MODEL	DIMENSIONI DIMENSIONS			CAPACITÀ DI STOCCAGGIO STORAGE CAPACITY
	A	B	C	
ECO 310 CR	1340	850	1170	2 fusti da 200 lt. direttamente su grigliato o su europallet 1200x800 2x200 l drums directly on grille or on europallet 1200x800



**ECO 309 CRZ**

### VASCHE MOBILI DI RACCOLTA ZINCATE

- Concepite appositamente per le movimentazioni all'interno dell'azienda.
- Facile movimentazione grazie al maniglione di spinta e a 2 ruote fisse e a 2 piroettanti con freno.
- Consentono lo stoccaggio in verticale dei fusti e, con l'impiego dei supporti opzionali, anche in posizione orizzontale
- Su richiesta è disponibile la cinghia di trattenuta fusti con staffa di fissaggio per una maggiore sicurezza in fase di trasporto.

### GALVANIZED MOBILE STEEL SUMPS

- *Designed for an easy and safe handling within the Company area.*
- *Easy to move thanks to the handle and the 2 fixed and the 2 swivel castors with brake.*
- *Vertical drums storage and, with the additional support, also horizontally.*
- *On request also available a drum securing strap for a safe transport.*

**DISPONIBILE ANCHE VERNICIATO**  
**ALSO AVAILABLE PAINTED FINISHING**

MODELLO MODEL	DIMENSIONI DIMENSIONS			CAPACITÀ DI STOCCAGGIO STORAGE CAPACITY
	A	B	C	
ECO 309 CRZ	860	860	1170	1 fusto da 200 lt. direttamente su grigliato 1x200 l drum directly on grille



**CTF 200 Z**

A richiesta è disponibile una cinghia di trattenuta fusti con staffa di fissaggio per una migliore sicurezza durante la movimentazione

*On request also available a drum securing strap for a safe transport in the company area*



**ECO 310 CRZ**



**ECO 310 CRZ**

MODELLO MODEL	DIMENSIONI DIMENSIONS			CAPACITÀ DI STOCCAGGIO STORAGE CAPACITY
	A	B	C	
ECO 310 CRZ	1340	850	1170	2 fusti da 200 lt. direttamente su grigliato o su europallet 1200x800 2x200 l drums directly on grille or on europallet 1200x800

## SUPPORTI SOVRAPPONIBILI PER STOCCAGGIO FUSTI IN ORIZZONTALE

### STACKABLE SUPPORTS TO STORE DRUMS HORIZONTALLY

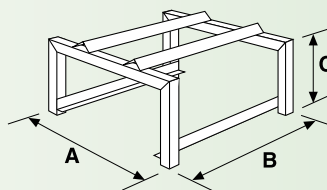

SPF 451

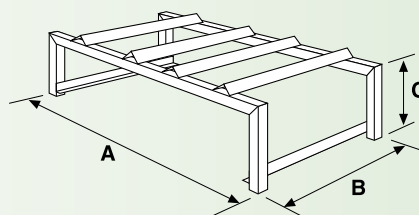

SPF 452

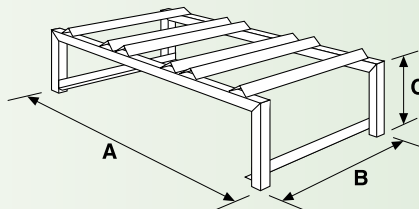

SPF 453

MODELLO MODEL	DIMENSIONI DIMENSIONS			CAPACITÀ DI STOCCAGGIO STORAGE CAPACITY
	A	B	C	
SPF 451	600	600	380	1 fusto da 200 Lt. 1 x 200 l. drum
SPF 452	1180	600	380	2 fusti da 200 Lt. 2 x 200 l. drums
SPF 453	1180	600	380	3 fusti da 60 Lt. 3 x 60 l. drums



### SUPPORTO INCLINATO PER FUSTI FINO A Ø 600

#### TILTED SUPPORT FOR DRUMS UP TO Ø 600

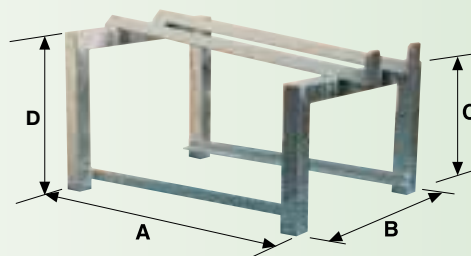

MODELLO MODEL	DIMENSIONI DIMENSIONS				CAPACITÀ DI STOCCAGGIO STORAGE CAPACITY
	A	B	C	D	
SPF 451 INZ	800	600	380	450	1 fusto da 200 Lt. 1 x 200 l. drum

# SUPPORTI SOVRAPPONIBILI PER STOCCAGGIO FUSTI IN ORIZZONTALE

## STACKABLE SUPPORTS TO STORE DRUMS HORIZONTALLY

# A



**SPT 011Z**  
SUPPORTO  
PER TRAVASO  
ZINCATO  
GALVANIZED  
SUPPORT  
FOR TRANSFER  
OPERATIONS

**SPF 353**



**SPF 352**

**SPF 352**

**ECO 308 F**



**SPF 373**

**SPF 373**

**ECO 308 F**

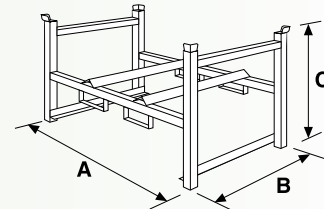

**SPF 351**  
Per 1 fusto  
da 200 litri  
For 1 x 200  
litre drum

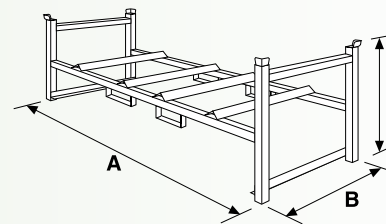

**SPF 352**  
Per 2 fusti  
da 200 litri  
For 2 x 200  
litre drums

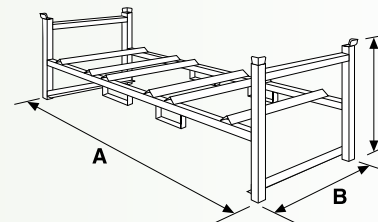

**SPF 353**  
Per 3 fusti  
da 60 litri  
For 3 x 60  
litre drums

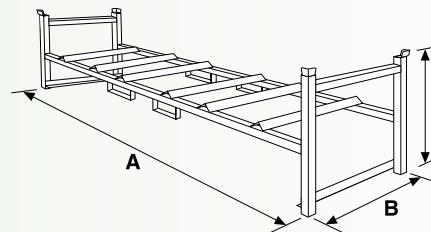

**SPF 373**  
Per 3 fusti  
da 200 litri  
For 3 x 200  
litre drums

MODELLO MODEL	DIMENSIONI DIMENSIONS			CAPACITÀ DI STOCCAGGIO STORAGE CAPACITY
	A	B	C	
SPF 351	835	600	810	1 fusto da 200 Lt. 1 x 200 l. drum
SPF 352	1335	600	810	2 fusti da 200 Lt. 2 x 200 l. drums
SPF 353	1335	600	810	3 fusti da 60 Lt. 3 x 60 l. drums
SPF 373	1960	600	810	3 fusti da 200 Lt. 3 x 200 l. drums

- Con questo sistema si possono stoccare in un'unica struttura diversi tipi di contenitori e confezioni adattandoli alle diverse esigenze di lavorazione.
  - Il travaso dei fusti in orizzontale avviene in tutta sicurezza sopra la vasca di raccolta.
  - Le scaffalature possono essere trasportate singolarmente mediante il carrello elevatore.
  - In questo modo è facilitato il procedimento di carico.
  - Le vasche sono realizzate in lamiera zincata poi saldata.
  - Supporti verniciati.
  - Portata ripiano: kg 500
- Thanks to this system, different types of containers and packages can be stored in a single structure and adapted to different working requirements.
  - Horizontal drum transfer is done in total safety above the storage tank.
  - Shelving can be transported individually using a fork-lift truck.
  - This way loading is made easier.
  - Tanks made of galvanised and welded metal sheet
  - Painted supports.
  - Shelf load-bearing capacity: 500 kg

SCAFFALATURA PER CONTENITORI E TANICHE COSTITUITA DA:  
1 vasca ECO 364Z, da 1 supporto SPG 381 e da 2 supporti SPK 381.  
SHELVING FOR CONTAINERS AND CANS CONSISTING OF:  
1 tank ECO 364Z, 1 support SPG 381 and 2 supports SPK 381.



SCAFFALATURA PER CONTENITORI COSTITUITA DA:  
1 vasca ECO 364Z e da 2 supporti SPG 381  
SHELVING FOR CONTAINERS CONSISTING OF:  
1 tank ECO 364Z and 2 supports SPG 381.



SCAFFALATURA PER CONTENITORI COSTITUITA DA:  
1 vasca ECO 364Z e da 1 supporto SPG 381  
SHELVING FOR CONTAINERS CONSISTING OF:  
1 tank ECO 364Z and 1 support SPG 381.



SCAFFALATURA PER CONTENITORI COSTITUITA DA:  
1 vasca ECO 365Z e da 2 supporti SPG 383  
SHELVING FOR CONTAINERS CONSISTING OF:  
1 tank ECO 365Z and 2 supports SPG 383.

A RICHIESTA  
SUPPORTI ZINCATI A CALDO  
ON DEMAND  
HOT-GALVANIZED SUPPORTS

MODELLO MODEL	VASCA TANK ECO 364Z	VASCA TANK ECO 365Z	SUPPORTO SUPPORT SPF 381	SUPPORTO SUPPORT SPF 383
Misure larg. x prof. x alt. (mm) Measurements w x d x h (mm)	715x1240x255	1215x1240x190	835x590x790	1335x590x790
Volume di raccolta Lt. Collection volume L.	205	270	-	-
Capacità di stoccaggio Storage capacity	-	-	1 fusto da 200 Lt. 1 x 200 l. drum	3 fusti da 60 Lt. 3 x 60 l. drums
Portata kg Load-bearing capacity kg	-	-	300	400

# SUPPORTI SOVRAPPONIBILI CON VASCA DI RACCOLTA

## STACKABLE SUPPORTS WITH COLLECTION TANK

# A



SCAFFALATURA PER FUSTI E CONTENITORI  
COSTITUITA DA: 1 vasca ECO 365Z, da 1 supporto  
SPG 383 e da 1 supporto SPF 383  
SHELVING FOR DRUMS AND CONTAINERS CONSISTING OF:  
1 tank ECO 365Z, 1 support SPG 383 and 1 support SPF 383



SCAFFALATURA PER TANCHE COSTITUITA DA:  
1 vasca ECO 365Z e da 2 supporti SPK 383  
SHELVING FOR CANS CONSISTING OF:  
1 tank ECO 365Z and 2 supports SPK 383.

VASCHE IN  
LAMIERA ZINCATA  
TANKS MADE OF  
GALVANIZED SHEET METAL



COMBINANDO I SUPPORTI SOVRAPPONIBILI  
CON LA VASCA DI RACCOLTA SI OTTENGONO  
DIVERSE SOLUZIONI DI SCAFFALI.

THANKS TO THE COMBINATION OF STACKABLE  
SUPPORTS WITH COLLECTION TANK, VARIOUS  
SHELVING SOLUTIONS CAN BE MADE.



SCAFFALATURA PER CONTENITORI E TANCHE  
COSTITUITA DA: 1 vasca ECO 365Z, da 1 supporto  
SPG 383 e da 1 supporto SPK 383  
SHELVING FOR CONTAINERS AND CANS CONSISTING OF:  
1 tank ECO 365Z, 1 support SPG 383 and 1 support SPK 383.

MODELLO MODEL	SUPPORTO SUPPORT SPK 381	SUPPORTO SUPPORT SPK 383	SUPPORTO SUPPORT SPG 381	SUPPORTO SUPPORT SPG 383
Misure larg. x prof. x alt. (mm) Measurements w x d x h (mm)	835x590x790	1335x590x790	835x1142x790	1335x1210x790
Volume di raccolta Lt. Collection volume L.	-	-	-	-
Capacità di stoccaggio Storage capacity	3 canestri da 30 Lt. o 2 canestri da 60 Lt. 3 x 30 l. or 2 x 60 l. baskets	4 canestri da 30 Lt. o 3 canestri da 60 Lt. 4 x 30 l. or 3 x 60 l. baskets	Piccoli contenitori Small containers	Piccoli contenitori Small containers
Portata kg Load-bearing capacity kg	350	400	300	400



SCAFFALATURA PER FUSTI DA 200 LT COSTITUITA DA:  
1 vasca ECO 363Z e da 2 supporti SPF 362  
SHELVING FOR 200 LITRE DRUMS CONSISTING OF:  
1 tank ECO 363Z and 2 supports SPF 362.

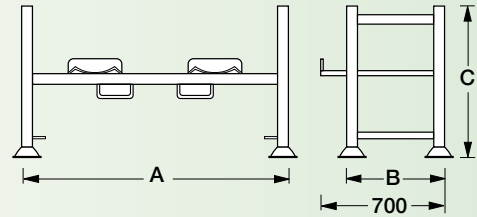

MODELLO MODEL	DIMENSIONI DIMENSIONS			CAPACITÀ DI STOCCAGGIO STORAGE CAPACITY
	A	B	C	
SPF 362	1500	550	850	2 fusti da 200 Lt. 2 x 200 l. drums

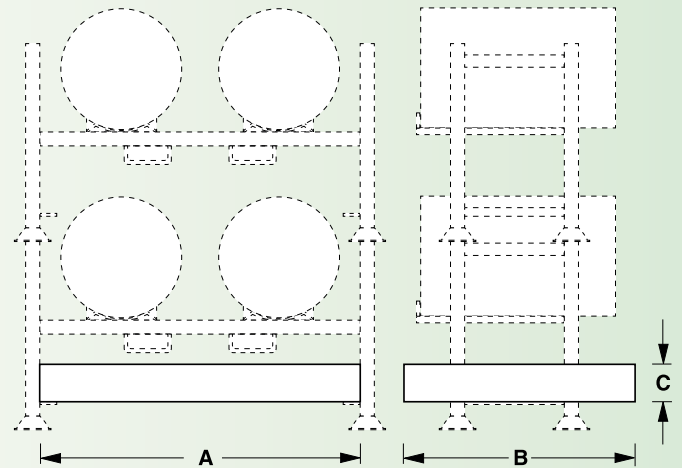

MODELLO MODEL	DIMENSIONI DIMENSIONS			VOLUME DI RACCOLTA LT. COLLECTION VOLUME L.
	A	B	C	
ECO 363Z	1390	1160	170	270

## PORTAFUSTI SOVRAPPONIBILE PER FUSTI FINO A Ø 600

### STACKABLE DRUM CARRIERS FOR DRUMS UP TO Ø 600

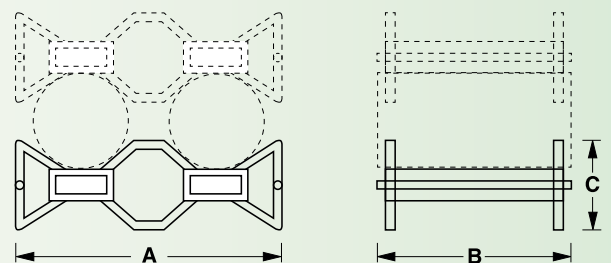
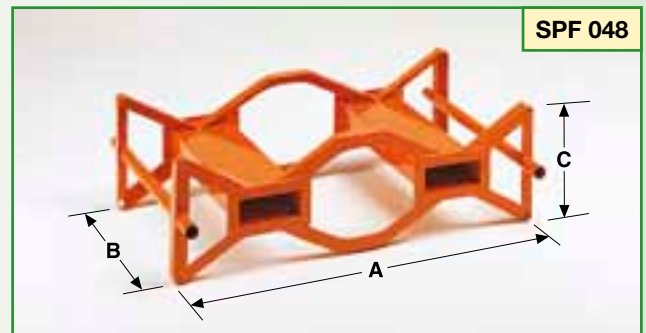

MODELLO MODEL	DIMENSIONI DIMENSIONS			CAPACITÀ DI STOCCAGGIO STORAGE CAPACITY
	A	B	C	
SPF 048	1170	750	360	2 fusti da 200 Lt. 2 x 200 l. drums

**Novità**  
New

### STAZIONI DI TRAVASO E IMMAGAZZINAGGIO FUSTI.

- Permettono di immagazzinare ed effettuare il travaso di fusti da 200 litri velocemente e con la massima sicurezza.
- Struttura e supporti realizzati zincati a caldo.
- La vasca è realizzata in lamiera zincata poi saldata.

### DISPENSING STATION – DRUMS STORAGE

- For an easy and safely dispensing of hazardous substance ideal for 200 l drums
- Structure & supports hot-dip galvanized
- Sealed galvanized sheet metal sump



SPF 048Z

SPS 464Z



SPF 048Z

SPS 462Z



SPF 048Z

SPF 048Z

SPS 464Z

MODELLO MODEL	SPS 462Z	SPS 464Z	SPS 464LZ
Capacità di stoccaggio Storage capacity	2 fusti da 200 Lt. 2 x 200 l. drums	4 fusti da 200 Lt. 4 x 200 l. drums	4 fusti da 200 Lt. 4 x 200 l. drums
Misure esterne larg. x prof. x alt. (mm) External dimensions w x d x h (mm)	1500x1200x665	2900x1200x665	2900x1200x665
Volume di raccolta Lt. Collection volume L.	220	268	400
Portata kg Capacity kg	600	1200	1200



# VASCHE DI CONTENIMENTO IN ACCIAIO PER CISTERNETTE

## STEEL SUMPS FOR STORING IBCs

ESEMPIO DI COMPOSIZIONE DI UNA STAZIONE DI STOCCAGGIO CON VASCA DI RACCOLTA PER 2 CISTERNETTE DA L. 1000  
 EXAMPLE OF COMPOSITION: STORAGE SPILL STATION FOR 2 IBCs



Pareti laterali paraspruzzi  
 Splash guard side

Supporti inclinati  
 Tilted supports

Vasca di raccolta  
 Spill sump

Grigliati zincati asportabili  
 Removable galvanized grid

- Una gamma completa di vasche di contenimento appositamente create per lo stoccaggio a norma di cisternette da 1000 lt.
- Consentono di immagazzinare sostanze infiammabili o inquinanti per le falde acquifere.
- Solida costruzione in acciaio con grigliato zincato asportabile.
- Ricca dotazione di accessori per migliorarne la funzionalità.
- Equipaggiate di pannelli monitori e targhetta identificativa.

- Complete range of steel spill sumps specially designed for the safe storage of IBCs in conformity with European standards.
- Approved for the storage of water polluting substances or flammable liquids.
- Strong steel construction with removable galvanized grid.
- Wide range of accessories to enhance the functionality.
- Equipped with identification plate, warning panels and registration booklet.

CONFORMI ALLE NORMATIVE EUROPEE DI SICUREZZA  
 IN CONFORMITY WITH EUROPEAN SAFETY STANDARDS

DOTATE DI EQUIPPED BY



LIBRETTO DI IMMATRICOLAZIONE E VERIFICA DI COLLAUDO  
 REGISTRATION BOOKLET AND TEST CERTIFICATE

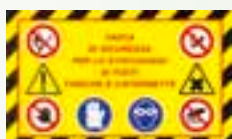

PANNELLI MONITORI  
 WARNING PANELS FITTED TO THE SUMP

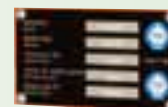

TARGHETTA IDENTIFICATIVA E D'IMMATRICOLAZIONE  
 IDENTIFICATION PLATE

# VASCHE DI CONTENIMENTO IN ACCIAIO PER CISTERNETTE

## STEEL SUMPS FOR STORING IBCs

# A

La Vasca ECO 310 ha il grigliato diviso per consentire la collocazione del supporto SPC 100 che permette di realizzare in sicurezza le operazioni di travaso.

*The ECO 310 tank has a split grille for fitting the SPC 100 support to ensure safe transfer operations.*



**SUPPORTO INCLINATO**  
**TILTED SUPPORT**

**MOD. SPC 100**

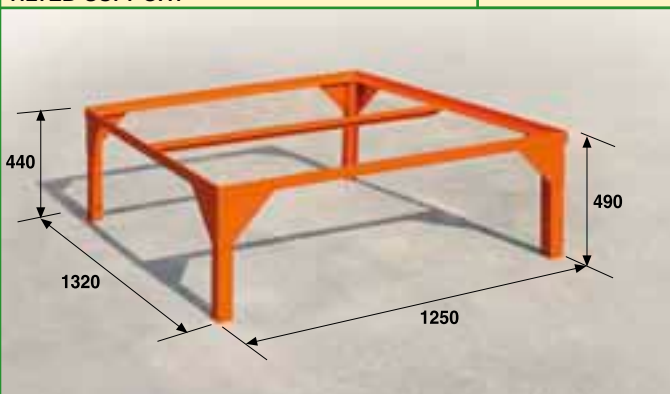

Il supporto SPC 100 è inclinato per permettere di eseguire facilmente travasi e dosaggi e di svuotare completamente la cisternetta.

*The SPC 100 support is tilted to facilitate transfer and dosing operations and ensure tank empties completely.*



**ECO 310**

MODELLO MODEL	DIMENSIONI DIMENSIONS			VOLUME DI RACCOLTA COLLECTION VOLUME
	A	B	C	
ECO 310	1340	1650	620	Lt. 1000

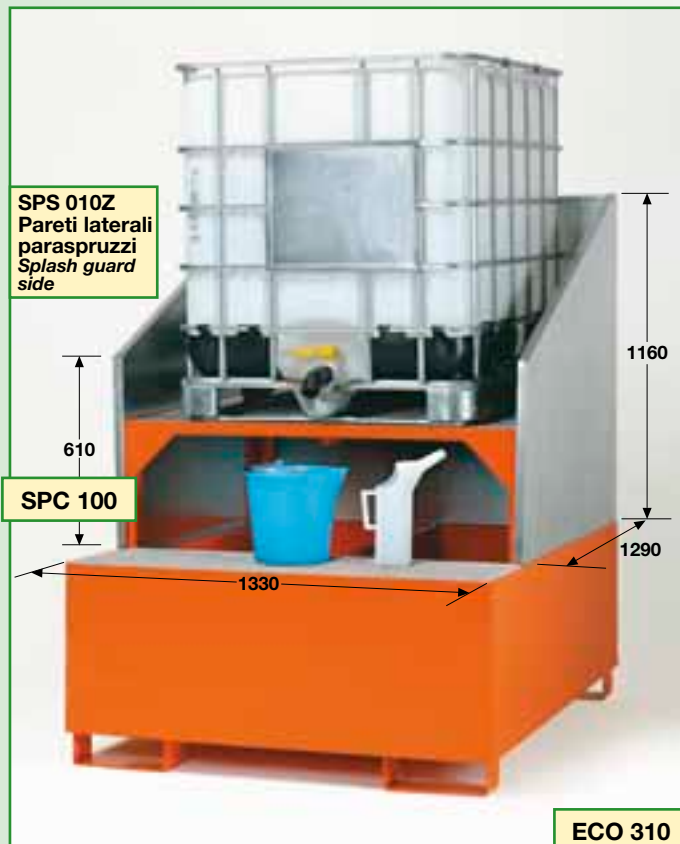

**SPS 010Z**  
Pareti laterali  
paraspruzzi  
Splash guard  
side

**SPC 100**

**ECO 310**



**SPC 100**  
Supporto  
inclinato  
Tilted  
support

**ECO 310**

# A

## VASCHE DI CONTENIMENTO IN ACCIAIO PER CISTERNETTE STEEL SUMPS FOR STORING IBCs



Supporto  
inclinato  
Tilted  
support

SPC 100

ECO 320



In tutti i modelli é possibile l'applicazione di un apposito ripiano rialzato ed inclinato che permette di eseguire facilmente travasi e dosaggi e di svuotare completamente la cisternetta.

Le versioni ECO 320 - ECO 321 sono stazioni ideali di lavoro, che permettono di realizzare in sicurezza le operazioni di travaso in quanto indirizzano eventuali fuoriuscite di liquido direttamente nella vasca di raccolta.

Ideate per lo stoccaggio di sostanze inquinanti.

Sono fornite a richiesta pareti laterali paraspruzzi in lamiera zincata.

*On all models it is possible to fit a special raised tilted shelf to facilitate transfer and dosing operations and ensure complete tank emptying. Versions ECO 320 - ECO 321 are ideal work stations which allow for completely safe transfer operations as they direct any possible liquid spillage to the collection tank.*

*Specifically designed for the storage of polluting substances.*

*Galvanised sheet splash guard sides are supplied on request.*



SPC 100

SPC 100

ECO 320



**OPTIONAL**  
**SPT 012Z**  
SUPPORTO PER  
TRAVASO ZINCATO  
GALVANIZED SUPPORT  
FOR TRANSFER  
OPERATIONS

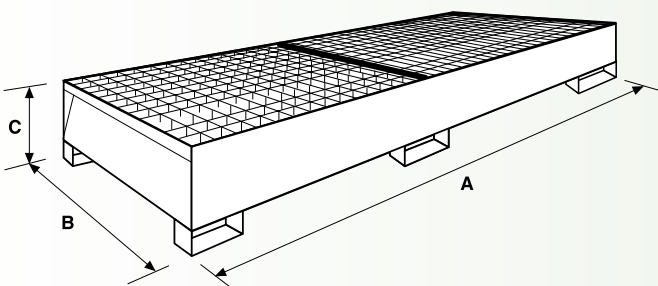

**CONFORMI ALLE NORMATIVE EUROPEE DI SICUREZZA**  
**IN CONFORMITY WITH EUROPEAN SAFETY STANDARDS**

MODELLO MODEL	DIMENSIONI DIMENSIONS			VOLUME DI RACCOLTA COLLECTION VOLUME
	A	B	C	
ECO 320	2720	1315	420	Lt. 1000

# VASCHE DI CONTENIMENTO IN ACCIAIO PER CISTERNETTE

## STEEL SUMPS FOR STORING IBCs

# A

Queste versioni consentono lo stoccaggio di due cisternette da 1000 litri e sono predisposte per l'applicazione di appositi ripiani rialzati ed inclinati che permettono di realizzare stazioni versatili in grado di consentire allo stesso tempo sia il travaso che lo stoccaggio.

Volume di raccolta di 1000 litri.

Le versioni ECO 320 - ECO 321 sono stazioni ideali di lavoro, che permettono di realizzare in sicurezza le operazioni di travaso, in quanto indirizzano eventuali fuoriuscite di liquido direttamente nella vasca di raccolta.

Ideate per lo stoccaggio di sostanze inquinanti.

A richiesta vengono fornite pareti laterali paraspruzzi in lamiera zincata.

*These versions are for the storage of two IBCs and can be fitted with suitable raised tilted shelves which allow for the setting up of versatile stations for simultaneous transfer operations and storage. Collection volume is 1000 litres. The ECO 320 - ECO 321 versions are ideal work stations which allow for completely safe transfer operations as they direct any possible liquid spillage to the collection tank. Specifically designed for the storage of polluting substances. Galvanised sheet splash guard sides are supplied on request.*



### COMBINAZIONE COMPOSTA DA:

- 1 vasca ECO 321
- 1 pareti laterali paraspruzzi SPS 020
- 2 supporti inclinati SPC 100

### COMBINATION CONSISTING OF:

- 1 ECO 321 tank
- 1 splash guard side SPS 020
- 2 tilted supports SPC 100



MODELLO MODEL	DIMENSIONI DIMENSIONS			VOLUME DI RACCOLTA COLLECTION VOLUME
	A	B	C	
ECO 321	2720	1650	350	Lt. 1000

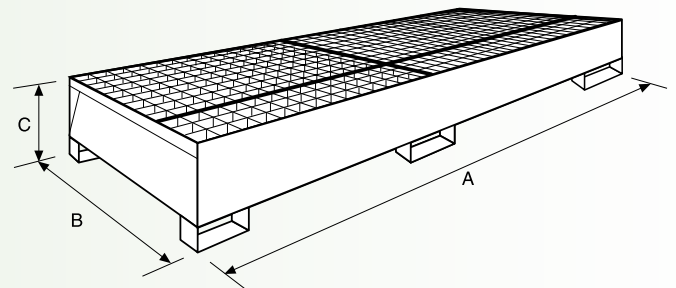

## PARETI LATERALI PARASPRUZZI IN LAMIERA ZINCATA

### GALVANIZED SHEET SPLASH GUARD SIDES



CISTERNETTE  
IBCs  
PAG. 255

In caso di sversamenti convogliano i liquidi all'interno della vasca di contenimento.  
In case of spills it conveys liquids into the sump.

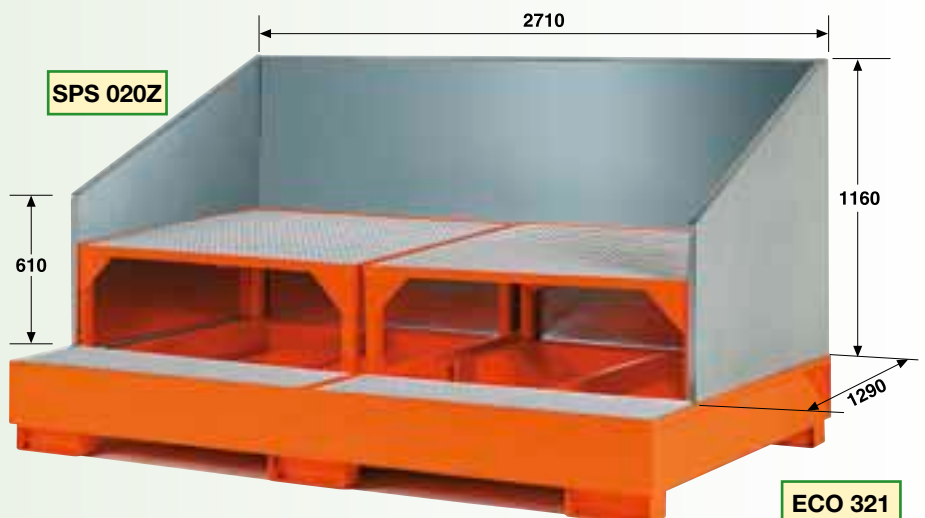

PER LO STOCCAGGIO DI CISTERNETTE CONTENENTI SOSTANZE CORROSIVE, VEDI DA PAGINA 40

FOR THE STORAGE OF IBCs CONTAINING CORROSIVE SUBSTANCES SEE PAGE 40

**Novità**  
New



VASCHE DI CONTENIMENTO IN ACCIAIO PER LO STOCCAGGIO DI CISTERNETTE DA LT 1000 O ALTRI PICCOLI CONTENITORI DOTATE DI PANNELLI MONITORI E TARGHETTA DI IDENTIFICAZIONE - CERTIFICAZIONE TUV.

STEEL SUMPS FOR THE STORAGE OF THREE IBCs OR SMALL CONTAINERS. EQUIPPED BY MONITORY PANEL AND IDENTIFICATION PLATE - TUV TESTED APPROVAL.



VASCA DI CONTENIMENTO PER CISTERNETTE COD. ECO330  
IBC STEEL SUMPS CODE - ECO330

MODELLO MODEL	DIMENSIONI DIMENSIONS			VOLUME DI RACCOLTA COLLECTION VOLUME
	A	B	C	
ECO 330	3280	1315	420	1200

- Realizzata in solida struttura d'acciaio e dotata di grigliato zincato asportabile
- A richiesta può essere fornita con supporto inclinato per agevolare le attività di picking.

PLUS: in caso di stoccaggio di sostanze aggressive come acidi o soluzioni alcaline è possibile inserire una vasca aggiuntiva in POLIETILENE.

Questa operazione (a richiesta ed opzionale) garantirà un doppio vantaggio:

- la robustezza del metallo
- la protezione del polietilene dall'attacco di sostanze aggressive

**PER ULTERIORI INFORMAZIONI CONSULTI IL NOSTRO UFFICIO TECNICO**

- Strong steel construction and galvanized removable grid.
- Available (on request) a tilted support to facilitate the picking operations

PLUS: for the storage of corrosive substances can be equipped by an inner POLYETHYLENE TANK. This operation (on request and optional) will assure a double benefit:

- The strength of the steel
- The protection of the polyethylene against corrosive substances

**FOR FURTHER INFORMATION PLEASE CONTACT OUR TECHNICAL DEPT.**



PER SOSTANZE CORROSIVE POSSIBILITÀ DI INSERIMENTO DI VASCA AGGIUNTIVA IN POLIETILENE (OPZIONALE)

FOR CORROSIVE SUBSTANCES THIS SUMP CAN BE EQUIPPED WITH A POLYETHYLENE ADDITIONAL TANK (OPTIONAL)



# VASCHE DI CONTENIMENTO IN ACCIAIO PER CISTERNETTE

## STEEL SUMPS FOR STORING IBCs

# A

**Novità**  
New



**ECO 310 LP**  
Interno vasca  
in polietilene  
*Polyethylene  
tank interior*

### RESISTENTE COME L'ACCIAIO PROTETTIVO COME IL POLIETILENE

Sall ha esteso la gamma dei propri sistemi ecologici in acciaio introducendo all'interno delle proprie vasche in metallo un "rivestimento" in polietilene.

Questo per realizzare un prodotto che combini le prestazioni di robustezza del metallo, non idoneo però con lo stoccaggio di molteplici sostanze corrosive, con il polietilene, ideale invece per questo uso ma più soggetto a rotture derivanti da urti accidentali o repentini sbalzi termici. Una seconda pelle che crea un prodotto completo sotto molteplici punti di vista.

### STRONG AS STEEL PROTECTIVE AS POLYETHYLENE

Sall has extended the range of its steel ecological products equipping the steel sumps with an internal polyethylene protection. With this solution we have achieved a product that combines the strength of the sheet metal, not compatible with the storage of many corrosive substances, with the polyethylene qualities, ideal for this use but more susceptible to breakage caused by accidental impact or sudden temperature changes. A "second skin" that creates a complete product from many points of view

ESTERNO VASCA IN ACCIAIO  
INTERNO VASCA IN POLIETILENE  
  
OUTER STEEL TANK  
INNER POLYETHYLENE TANK



**ECO 310 LP**  
Interno vasca  
in polietilene  
*Polyethylene  
tank interior*

Cisternetta  
Polybox 1000  
Vedi pag.255  
Polybox 1000  
IBC  
See page 255

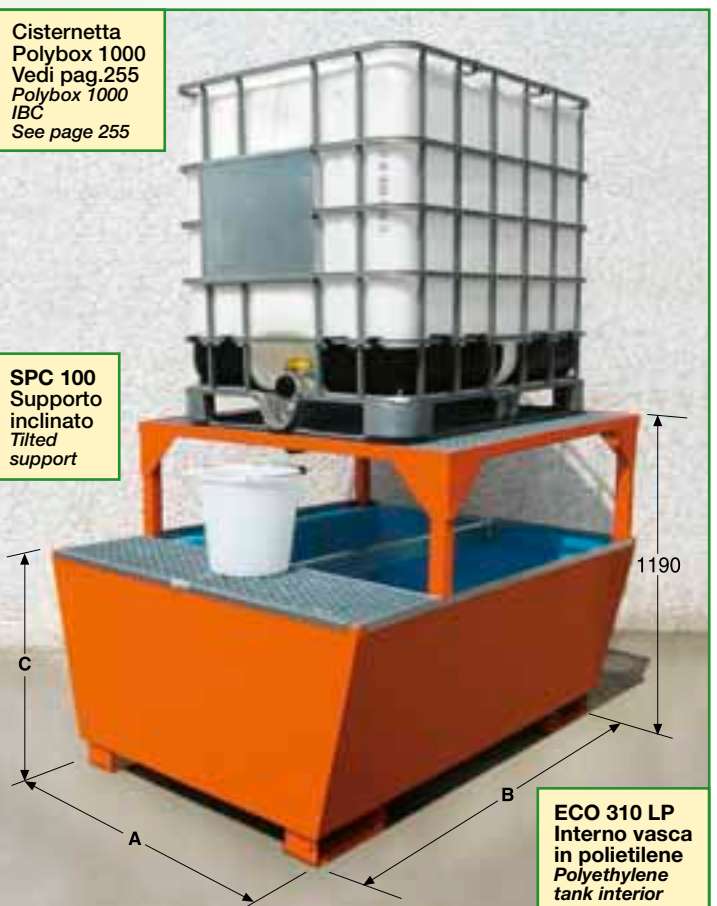

**SPC 100**  
Supporto  
inclinato  
*Tilted  
support*

**ECO 310 LP**  
Interno vasca  
in polietilene  
*Polyethylene  
tank interior*

**SUPPORTO INCLINATO**  
*TILTED SUPPORT*

**MOD. SPC 100**

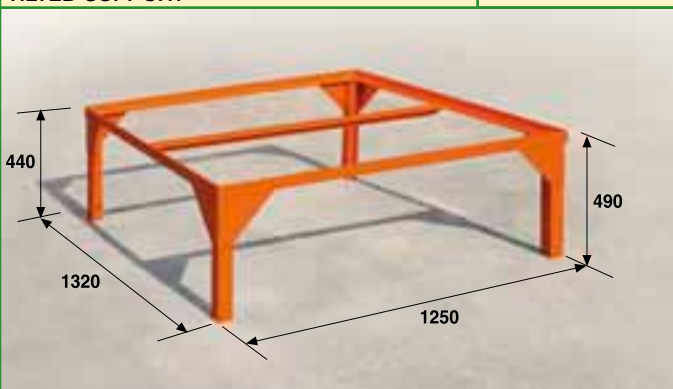

Il supporto SPC 100 è inclinato per permettere di eseguire facilmente travasi e dosaggi e di svuotare completamente la cisternetta.

*The SPC 100 support is tilted to facilitate transfer and dosing operations and ensure tank empties completely.*

MODELLO MODEL	DIMENSIONI DIMENSIONS			VOLUME DI RACCOLTA COLLECTION VOLUME
	A	B	C	
ECO 310 LP	1345	1655	730	Lt. 1000